

Development of Suspension P-S Logging System (Part 3)

Kenji TANAKA and Kimio OGURA

Abstract

We have been developing a Suspension P-S Logging System since 1974. This system has two types of seismic source. One of them is S source and another P-S source. The former generates only S (shear) waves. The latter generates both P (compressional) and S waves simultaneously.

Experiments to date have shown that in the ground having S wave velocity of less than 500 m/s, S source provides extremely good S waves, while in the ground having S wave velocity of over 500 m/s, P-S source worked more effective than S source. In the ground having S wave velocity exceeding 1 km/s, even the P-S source can no longer provides good S wave. In order to observe S wave in harder ground, new seismic source (H-S source) was developed. The difference between H-S source and conventional source consists in radiation power. To increase radiation power, we adopted two ways. One was enlarging the area of vibration plate, and another generating the high frequency wave. The vibration plate of H-S source was made in the cylindrical shape. The steel hammer was made to strike the inner surface of the vibration plate. Using H-S source, five-fold increase in radiation power could be achieved without increasing the energy for driving the source supplied from Suspension P-S Log Unit and without increasing the size of the source. Using this, it is now possible to obtain S wave records in ground having S wave velocity in excess of 1 km/s. H-S source can be used in ground having S wave velocity values of up to 3 km/s.

Damping values of the ground (Q-values), along with propagation velocity values, are important parameters for use in aseismic design. We use the Suspension P-S Logging System to measure in situ Q-values of the ground. Results showed changes in Q-values even within the ground having uniform velocities. Although this phenomenon has not yet been investigated in detail, we believe that analysis using Q-values along with other logging results, such as velocity, resistivity, magnetic susceptibility etc., offers more reliable information about grounds.

1. INTRODUCTION

Velocities of P (compressional) and S (shear) waves and Q-values are important parameters to estimate the dynamic qualities of the ground [Imai et. al. (1980)]. P-S Logging is widely used for measurement of these data. P-S Logging has two methods. One is down-hole method, with wave source on the ground surface and with receiver in the borehole. Another one is up-hole method, with wave source located in the borehole while receiver being on the ground surface. Each method determines the distribution of the P and S wave velocities from the travel-time curves of P and S waves which propagate along the borehole from wave source to receiver. Seismic source of the Suspension P-S Logging System generates the waves in the borehole and its two receivers receive them in the same borehole. And the propagation velocity between two receivers is determined.

In recent year, prior to building of structures, Suspension P-S Logging has been used, not only to determine the distribution of P and S wave velocities but also to correlate P and S wave velocities with the other physical properties. Ogura (1979), Ogura and Nakanishi (1980) reported the process of the development of the Suspension P-S Logging System. This paper reports the process of the development of new seismic source of this system and results of some field experiments. In addition, we tried to calculate the Q-values using the data from Suspension P-S Logging System, and this paper reports the results of it.

2. DEVELOPMENT OF THE NEW SEISMIC SOURCE FOR THE HARD GROUND

2.1 Conventional Seismic Source

Fig. 1 and Fig. 2 show the surface equipment and probe of Suspension P-S Logging System, we are now using. There are two types of seismic source. One is S source and another P-S source. S source (Fig. 3) consists of a hammer (H), two rubber plates (RP), which shield the inside of the source from the borehole fluid, solenoid coil (C), which drives the hammer. Rubber plates and hammer are connected with each other. There are two components as for solenoid coil. It is possible to change the excitation direction by driving either one of solenoid

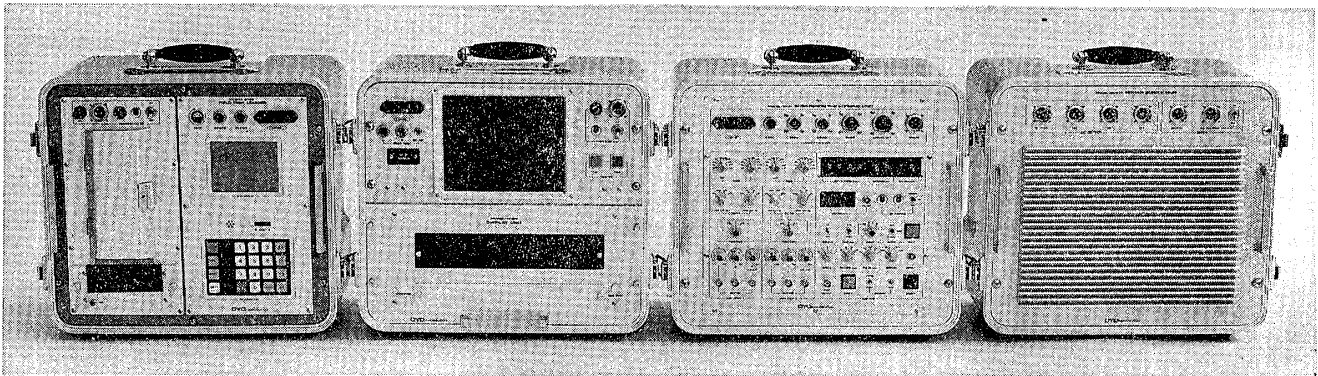

Fig.1 Surface equipment of Suspension P-S Logging System. From left to right, Field Disk Logger Unit, Display Unit, P-S Log unit and Power Supply Unit.

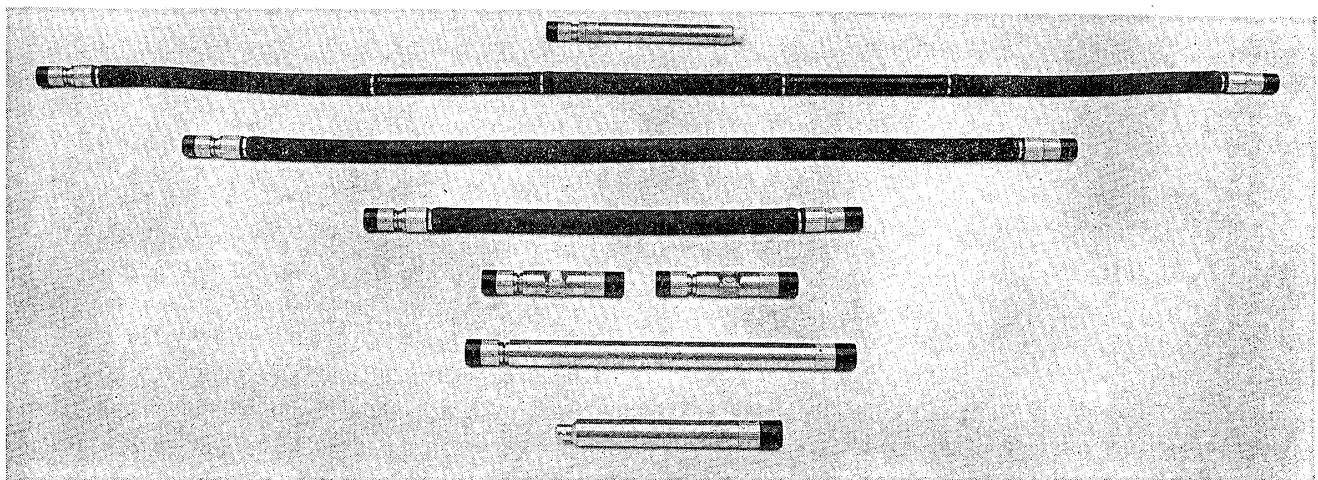

Fig.2 Probes of Suspension P-S Logging System. From top to bottom, Reducer- battery, Receiver, Filter tube (2 m), Filter tube (1 m), S source (left), P-S source (right), Driver and Weight.

coil components. When this source is driven, the hammer moves with two rubber plates and there is no change of volume of seismic source. Thus it generates only S waves propagated along the axis of borehole, and does not generate P wave.

P-S source (Fig. 4) consists of a hammer (H), two vibration plates made by steel (SP), solenoid coil (C), which drives the hammer, and springs (S), which suspend the hammer. This source generates waves through the vibration plate struck by the hammer. When the hammer strikes the plate, only one side of plate vibrates. Then the volume of the source is changed and P waves are generated. By using this source, it is possible to observe the S and P waves simultaneously. But what is more important than mere observation of S and P waves consists in the vibration velocity of the plates of P-S source heightened than the one of S source, which constitutes one of essential factors to enable Suspension P-S Logging System to be applied for hard ground. Fig. 5 shows the record examples obtained by using P-S source. The records on the right side, marked "UPPER", are the waveforms from the horizontal component of the upper receiver, which is more distant from the source. The records on the left side, marked "LOWER", are waveforms from the horizontal component of the lower receiver. Interval between two receivers is 1 m. The velocity is calculated from the reciprocal of the time difference between first arrivals of S waves or same phases of S waves. S wave velocities of this example range from 200 m/s to 500 m/s. In the low velocity (soft) ground as this example, very good records can be obtained. However, the force of this source is smaller than the explosive source or wooden plate striking source, and consequential amplitudes of S waves generated by the source of Suspension P-S Logging System is small. Relationship between the force of source (F) and amplitudes (U_s) of S waves are given by following equations [Kitsunezaki (1978)].

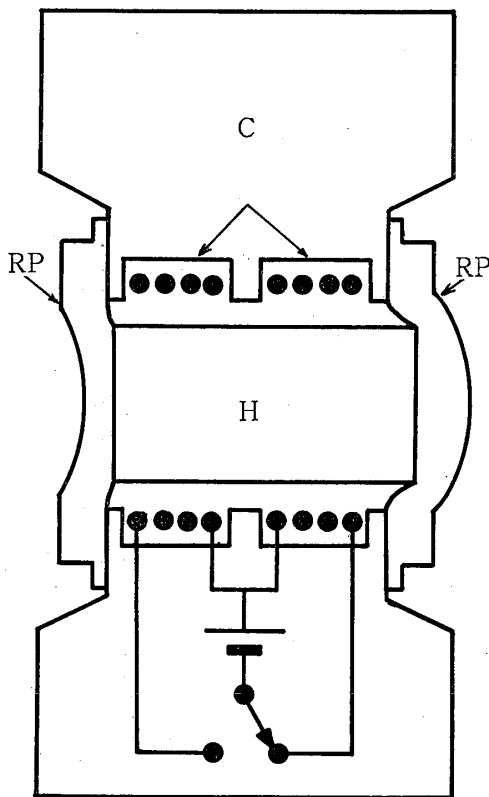

Fig. 3 Schematic diagram of S source.
H: hammer, RP: rubber plate,
C: solenoid coil.

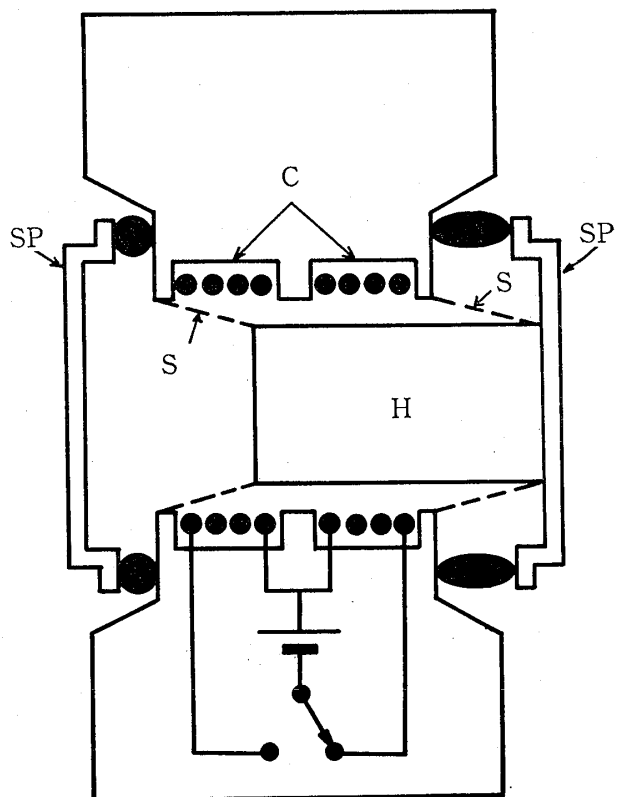

Fig. 4 Schematic diagram of P-S source.
H: hammer, SP: vibration plate made
by steel, C: solenoid coil, S: spring.

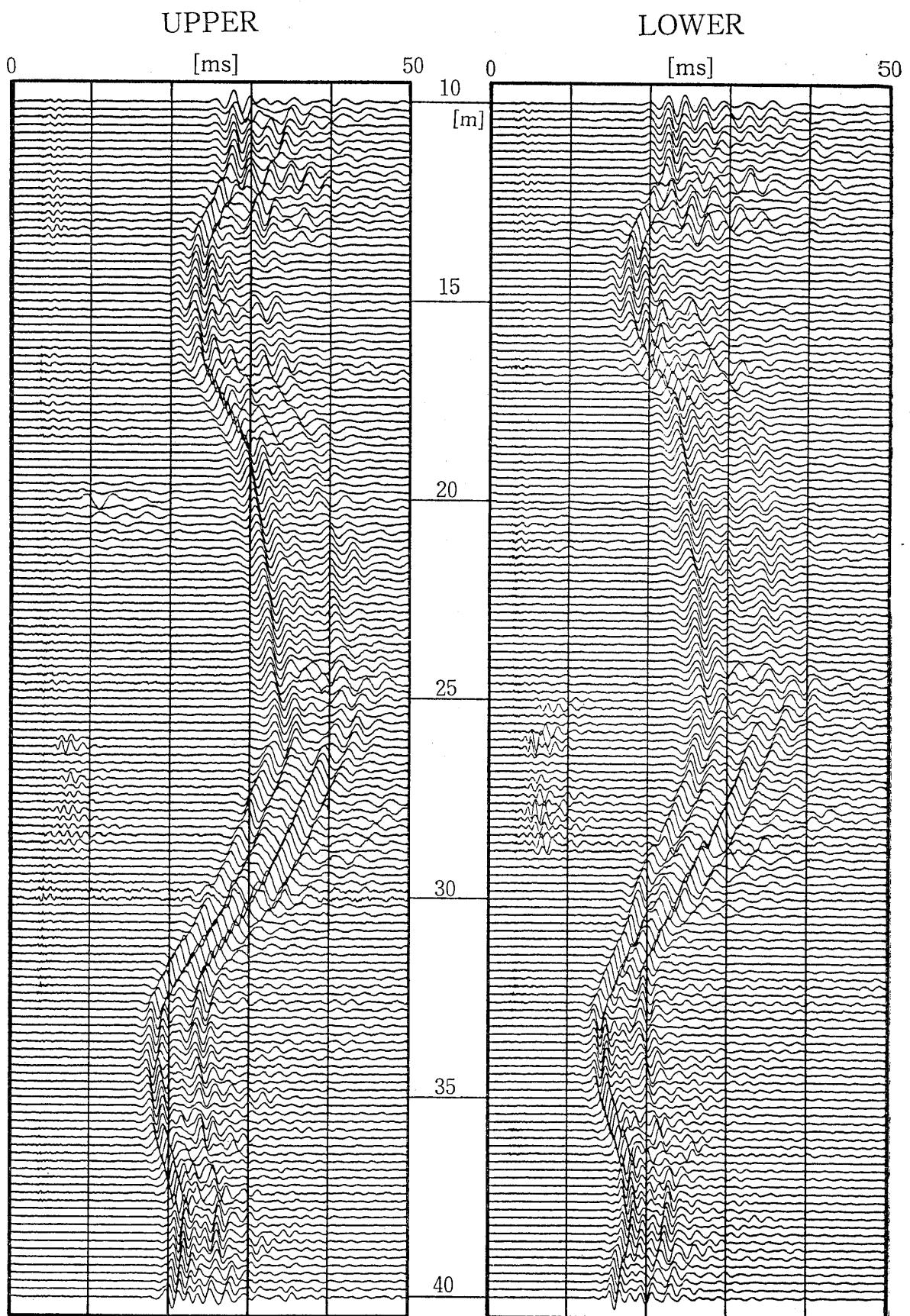

Fig.5 Record examples using P-S source.

$$U_s = \frac{F}{4\pi\rho V_s^2 r} \cdot \epsilon^{-\alpha r} \dots\dots\dots(1)$$

$$\begin{aligned} \dot{U}_s &= \frac{F}{2\rho V_s^2 r} \cdot \epsilon^{-\alpha r} \\ &= \frac{F \cdot f^2}{2\rho V_s^2 r} \cdot \epsilon^{-\alpha r} \dots\dots\dots(2) \end{aligned}$$

$$\begin{aligned} \ddot{U}_s &= \frac{\pi F}{\rho \lambda^2 r} \cdot \epsilon^{-\alpha r} \\ &= \frac{F \cdot f^2}{\rho V_s^2 r} \cdot \epsilon^{-\alpha r} \dots\dots\dots(3) \end{aligned}$$

where, ρ : density of the ground

V_s : velocity of S wave

r : distance from source

f : frequency of wave

α : damping value

λ : wave length

U_s : particle velocity of S wave

\dot{U}_s : particle acceleration of S wave.

Because of the geophones of velocity type being used for receivers, signal from receiver means particle velocity as according to equation (2). It is clear from equation (2) that as S wave velocity increases, so the amplitude decreases, even if the force of source is same. Followings are known from our experiences. In the ground with S wave velocity less than 500 m/s, good record can be obtained by using S source. Whereas in the ground with S wave velocity exceeding 500 m/s, P-S source offers better record than S source. In the ground

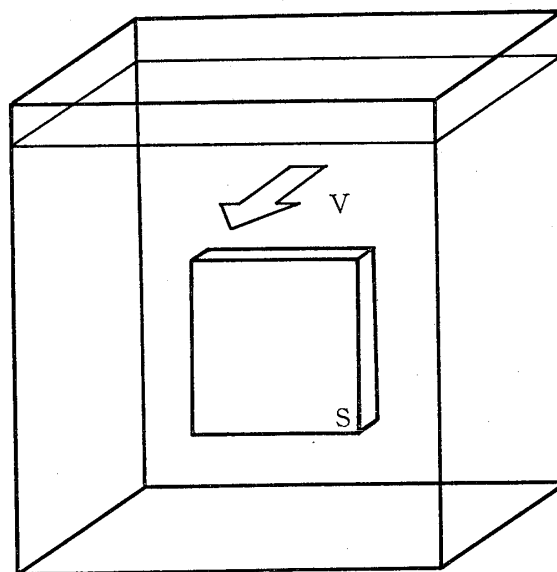

Fig. 6 Vibration plate in the fluid filled container.

V: vibration velocity, S: area of vibration plate.

with S wave velocity exceeding 1 km/s, the qualities of records using P-S source are decreasing and then it is difficult to determine the S wave velocities.

2.2 Improvement of the Force of Source

For generating the enough waves to observe in the hard ground, it is necessary that the force of source is increased. It is possible to increase the force of source simply by scaling up the size of source. However, it is undesirable, because it needs to expand the borehole in diameter. Therefore, our target is to develop the source, which generates waves more effectively, without changing the size of source nor changing the amount of energy to drive the source.

Firstly, let us consider the vibrating plate in the fluid filled container (Fig. 6). Pressure difference arises between the front and back side of the plate, from the vibration of plate. In the case of the container wall made of soft material (e. g. vinyl), the container wall easily vibrates with imparting vibrations to the plate and the consequential amplitude ratio between the plate and container wall vibration equals 1. However, in the case of the container wall made of rigid material (e.g. glass), the fluid in the container refluxes from high pressure area to low pressure area and the amplitude ratio between the plate and container wall vibration decreases. In other words, if the container wall is made of rigid material, it is difficult to vibrate the container wall. It is possible to increase the amplitude of the container wall vibration by increasing the vibration velocity. This means that the radiation power is augmented by increasing the vibration velocity. P-S source works more effective than S source in hard ground because it has greater radiation power.

In the case that only one plate vibrates as P-S source, radiation power (W) is expressed by equation (4).

$$W = \frac{S^2 V^2}{2\pi C^2} \cdot \rho \omega^2 \dots \dots \dots (4)$$

Where, : S : area of vibration plate
 V : vibration velocity
 ω : angular frequency
 C : propagation velocity
 ρ : density of medium through which waves propagate.

In the case that two plates vibrate as S source, radiation power is expressed in similar manner to equation (4). However, if the distance between the two vibration plates (d) satisfies the conditions expressed by equation (5), radiation power is expressed by equation (6).

$$2\pi d / \lambda \ll 1 \dots \dots \dots (5)$$

$$W = \frac{S^2 V^2 d^2}{12\pi C^3} \cdot \rho \omega^4 \dots \dots \dots (6)$$

As the S source, which we use, satisfies the condition expressed by equation (5), the radiation power can be expressed by equation (6). Both equation (4) and (6) show that radiation power may be increased by enlarging one or more of the terms S , v and ω .

The hammer of S source is connected to the two rubber plates. Therefore, movement of the hammer is limited, and vibration velocity becomes slower. The hammer of P-S source directly strikes the vibration plate, giving the higher vibration velocity than S source. Fig. 7 shows the spectra of the waves radiated by S source and P-S source. It means that the waves radiated by P-S source have higher frequency waves than S source. Therefore, P-S source has greater radiation power than S source. In further hard ground, the source with greater radiation power than P-S source must be used.

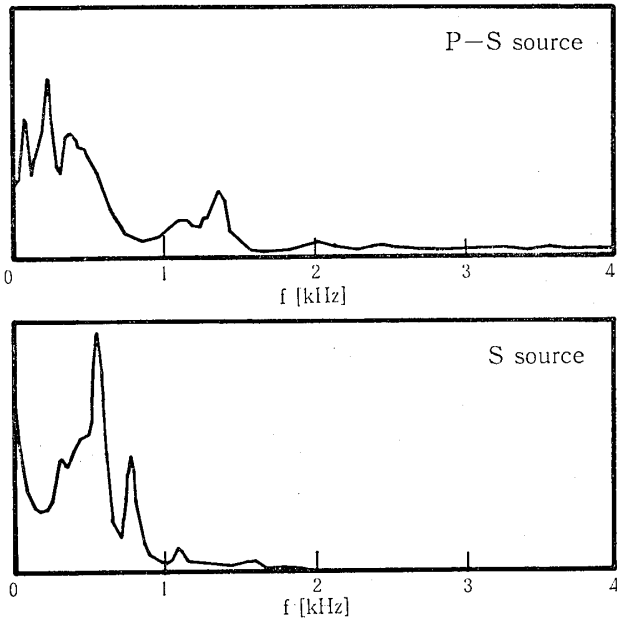

Fig.7 Spectra of the waves radiated by S source and P-S source.

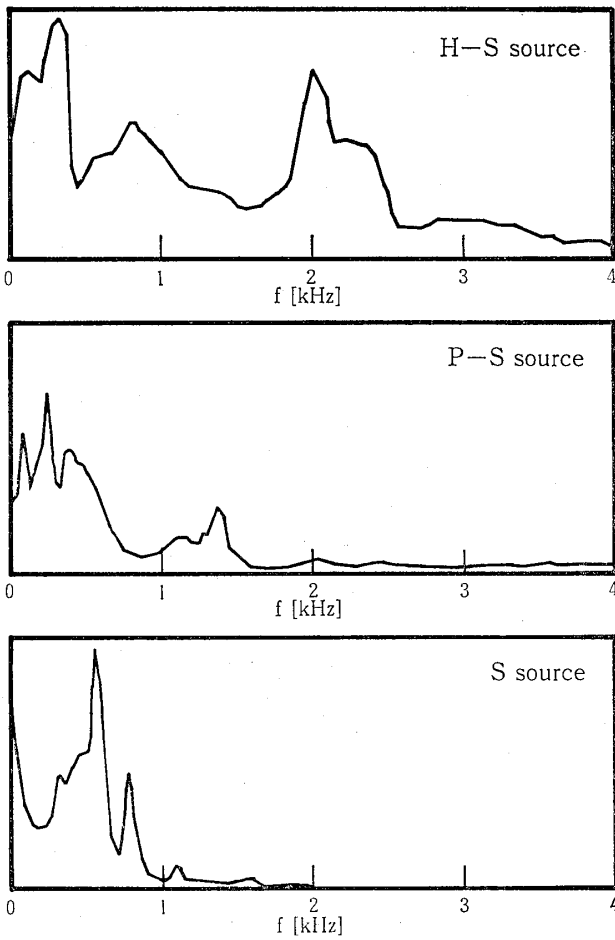

Fig.9 Spectra of the waves radiated by H-S source and conventional source.

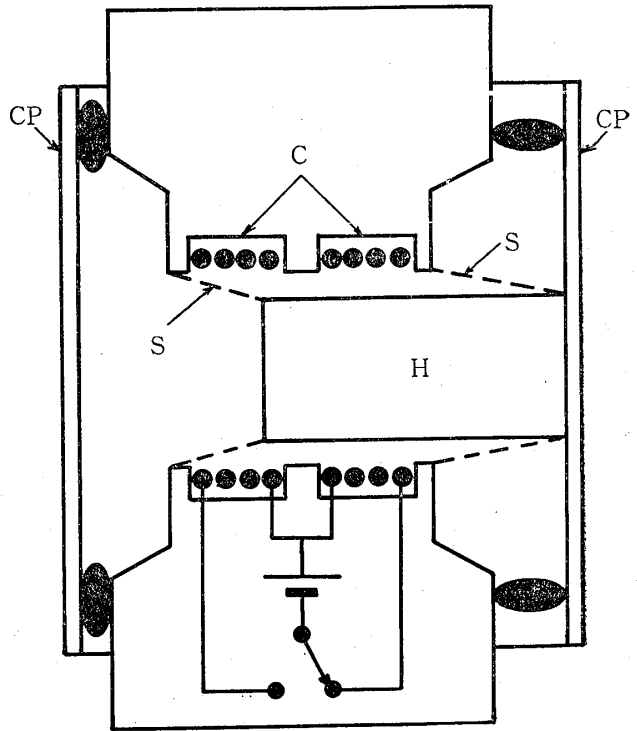

Fig.8 Schematic diagram of the H-S source. H: hammer, CP: vibration plate, C: solenoid coil.

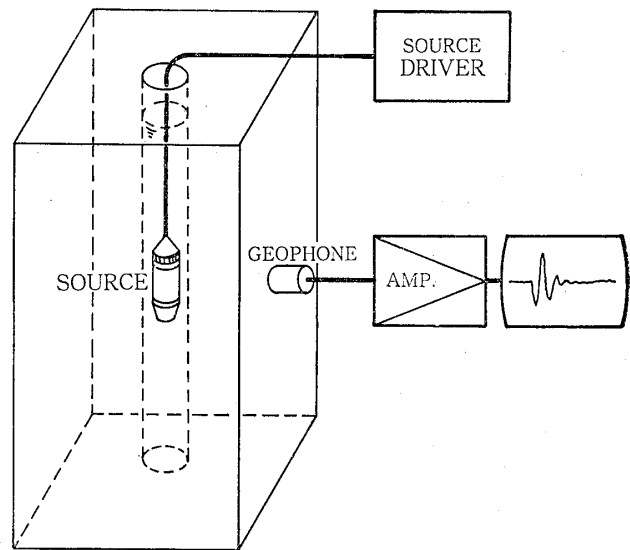

Fig.10 Comparative experiment in the test hole.

By the way, there is a big difference between equation (4) and (6). In equation (4), radiation power is proportionate to the square of ω , while in equation (6) radiation power is proportionate to ω raised to the fourth power. Therefore, it is possible to increase the radiation power of S source, if it is possible to generate higher frequency waves, like P-S source.

2.3 New Seismic Source (H-S Source)

Fig. 8 is the schematic diagram of the new seismic source. Since the source can be used in high speed layer, H-S source is named after the respective initial letters of high speed [K. Tanaka et. al. (1986)]. Equation (6) shows that the radiation power is increased by enlarging the area of vibration plate. Therefore, the vibration plate (CP) of new seismic source is made in cylindrical shape. Cylinder shaped vibration plate operates as same as two vibration plates vibrate simultaneously, like S source. In addition, to generate higher frequency waves, the hammer (H) strikes the inner surface of the vibration plate, like a P-S source. In Fig. 9, the spectrum of the wave which was generated by H-S source is shown. And also to compare, the spectra of the waves generated by S source and P-S source are shown in same figure. H-S source generates the higher frequency waves than those by both S source and P-S source.

2.4 Results from Experiment

To compare the each source, the experiment was made in the test hole drilled in a column shaped block of tuff ($0.7^W \times 0.7^D \times 1.3^H$ m). It has 2.4 km/s P wave velocity. S wave velocity is 1.0 km/s and density is 1.7g/cm^3 (obtained by the core sample test). The geophone was set on the side surface. The source was driven in the test hole (Fig. 10). Fig. 11 shows

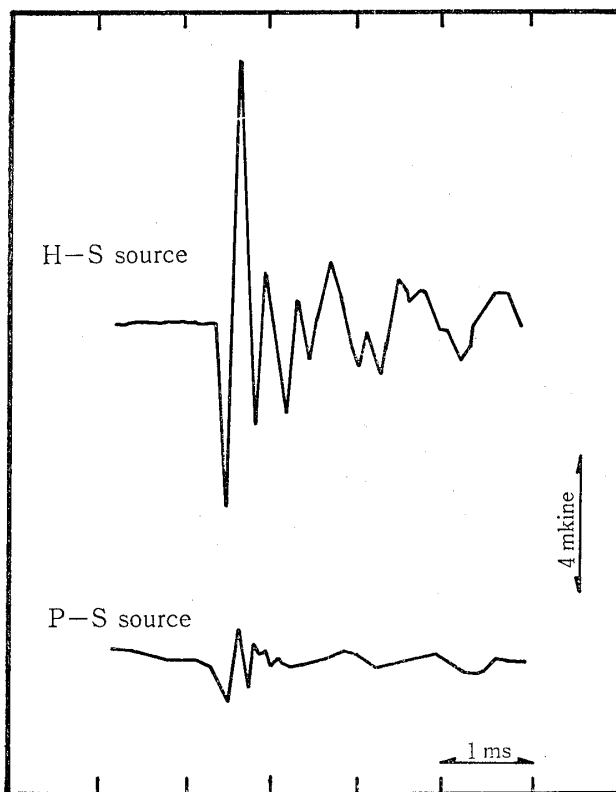

Fig.11 Comparison of waveforms obtained by H-S source and P-S source.

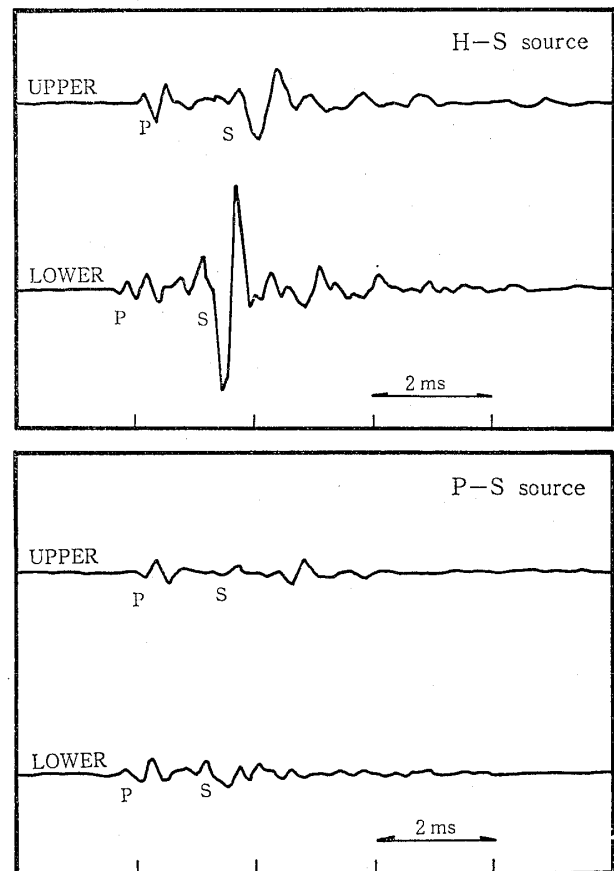

Fig.12 Example of waveforms.

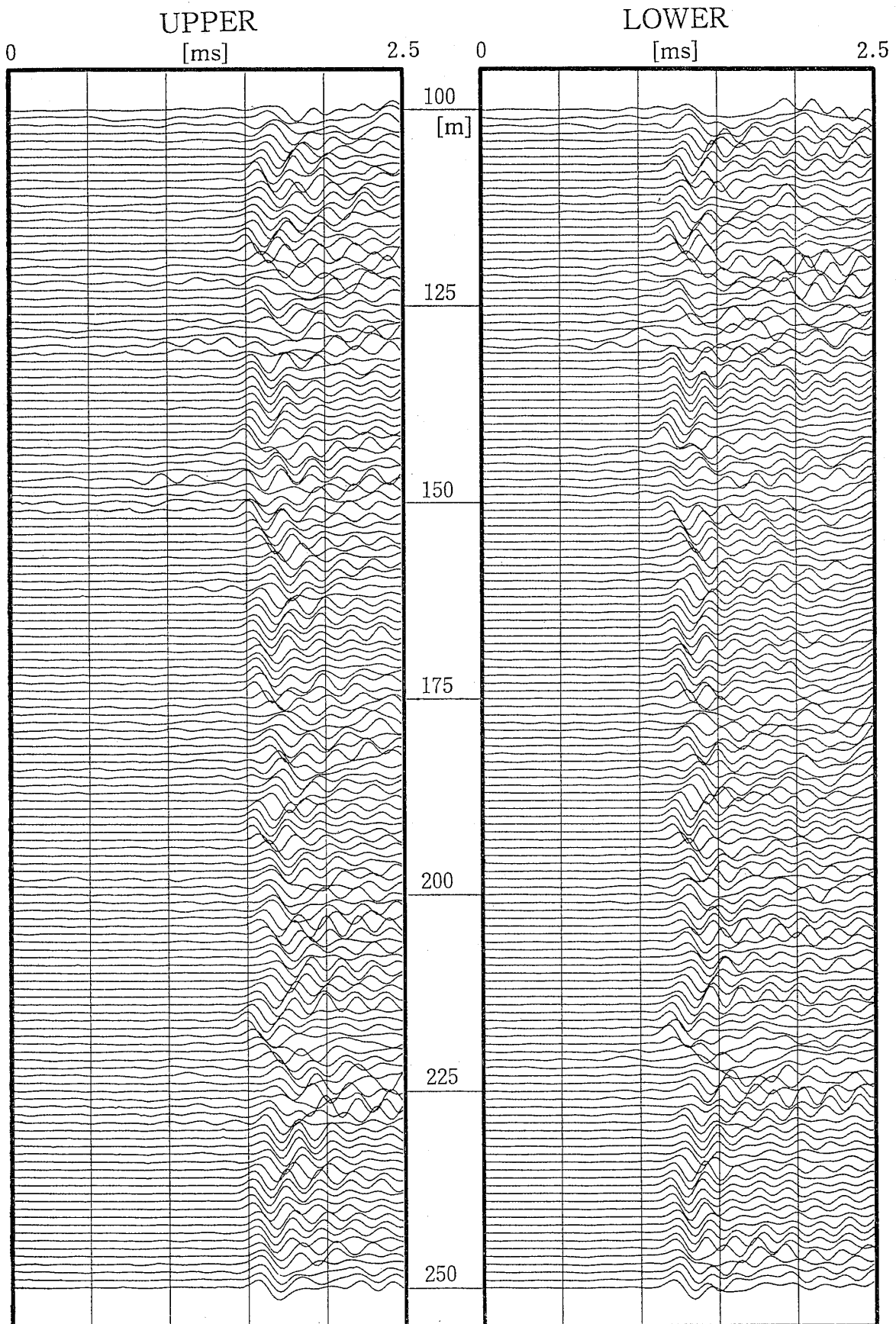

Fig. 13 Example of waveforms using H-S source.

the waveforms which observed in this experiment. With the S source, wave could not be observed. With H-S source, wave with approximately 5 times the amplitude of P-S source was observed. Fig. 12 is an example of waveforms observed by using H-S source and P-S source. Upper two traces are from the H-S source and lower two traces are from the P-S source. Each trace is observed at same depth. All amplitudes are drawn to the same scale. In the figure the traces marked "UPPER" are obtained the receiver placed more distantly from the seismic source, and "LOWER" are from the more closely placed receiver. The greater efficiency of the H-S source shows up particularly well in the S wave portion. Fig. 13 is a record using H-S source from the experiment, which was conducted jointly with Queen's University in Canada. With P-S source, it was impossible to obtain enough records to determine S wave velocity, however, with H-S source, it was possible to obtain sufficient records for determining the S wave velocity. Granite with 2.5 km/s to 3km/s S wave velocity formed the ground of this site.

3. CALCULATION OF DAMPING VALUES (Q VALUES)

3.1 Q Values

Amplitude of wave observed at distance Z from source is expressed by equation (7).

$$A(Z) = A_0 \exp\left(-\frac{\omega \cdot Z}{2CQ}\right) \cdot G(Z) \dots\dots\dots(7)$$

where $A(Z)$: amplitude at the distance Z from the source

A_0 : amplitude at the source

Z : distance from the source

ω : angular frequency

C : propagation velocity of wave

Q : damping value

$G(Z)$: geometric attenuation factor.

Usually, because amplitude at the source (A_0) is unknown, it is impossible to calculate Q values by equation (7). Then Q values can be calculated by using the ratio of amplitudes which are observed at two sites. Logarithmic of amplitude ratio expressed by equation (8).

$$\ln\left(\frac{A(Z_2)}{A(Z_1)}\right) = -\frac{(Z_2 - Z_1)\omega}{2CQ} + \ln\left(\frac{G(Z_2)}{G(Z_1)}\right) \dots\dots\dots(8)$$

where Z_1 : distance from source to receiver 1

Z_2 : distance from source to receiver 2

($Z_1 < Z_2$)

$A(Z_1)$: amplitude at receiver 1

$A(Z_2)$: amplitude at receiver 2

From equation (8), Q value is expressed by equation (9).

$$Q = -\frac{(Z_2 - Z_1) \cdot \omega}{2C \left(\ln \frac{A(Z_2)}{A(Z_1)} - \ln \frac{G(Z_2)}{G(Z_1)} \right)} \dots\dots\dots(9)$$

3.2 Calculation of Q Value in Suspension P-S Log Method

Fig. 14 (a) shows the schematic diagram of Suspension P-S Logging System. It is assumed that distance from source to receiver 1 and to receiver 2 are Z_1 and Z_2 respectively

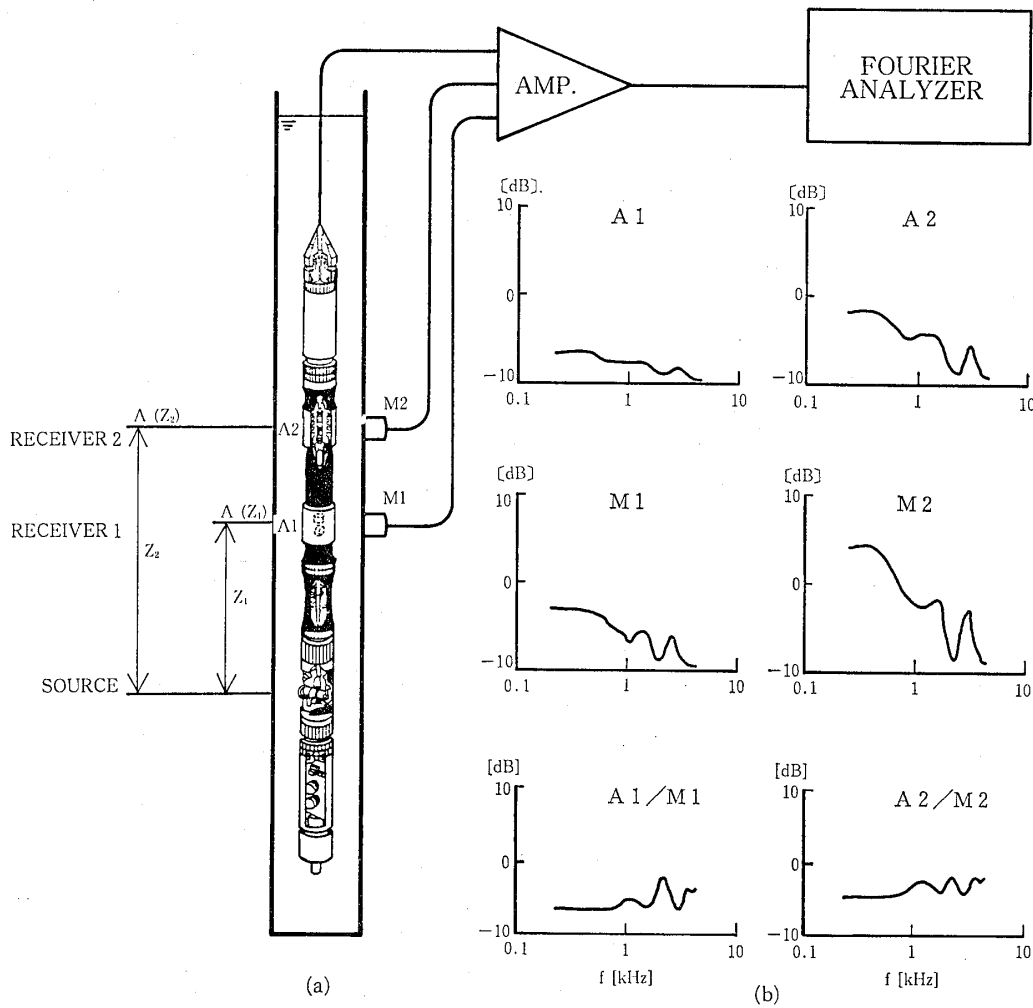

Fig. 14 (a) Schematic diagram of Suspension P-S Logging System.
 (b) Correction of system response

and that amplitudes of signals from each receiver are $A(Z_1)$ and $A(Z_2)$ respectively. In the case of Suspension P-S Logging, regardless of measuring points, Z_1 and Z_2 are uniform and distance between each receivers ($Z_2 - Z_1$) is 1 m. As such, equation (9) can be simplified to equation (10).

$$Q = - \frac{\omega}{2C \left(\ln \frac{A(Z_2)}{A(Z_1)} - G_0 \right)} \dots \dots \dots (10)$$

Where $G_0 = \ln(G(Z_2)/G(Z_1))$: constant.

By the way, since Q values are calculated from the amplitudes of ground motions, output from the system should be used in calculation of Q values after correcting the system response characteristic to the ground motion. In the case of Suspension P-S Logging, probe response to the ground motion, sensitivity characteristic of receiver and characteristics of both amplifier and A/D converter should be corrected. Fig. 14(b) describes such correction method. The probe is suspended in the fluid filled pipe. Two calibrated geophones are attached, 1 m apart with each other, to the outside of the pipe on the same level and to the same direction of the geophones of probe's receiver. The side of the pipe is struck, and the response of the receivers

to the movement of the pipe is recorded to determine the characteristic of the probe. It was found that the responses of the probe's receivers used for analysis were uniform within a frequency band less than 1 kHz and that sensitivity of receiver A2 was about 3 dB higher than that receiver A1 (Fig. 14(b)). Records used for analysis is as same as Fig. 5. After correcting system response, waveforms are used for analysis. These waveforms involve S waves, P waves (around 5 ms) and S waves reflected at the layer boundary (near 30 m depth). For calculating Q values of S waves, no wave other than S waves is actually needed. In addition, no wave other than those directly propagated from the source (e.g. reflected waves) is needed, because of difficulty to estimate the amount of geometric attenuation. Therefore, only one wave-length of the first arrivals of S waves was used for analysis. Since only one wave-length is insufficient for spectrum analysis using FFT, MEM (Maximum Entropy Method) was used.

3.3 Results

Fig. 15 shows analysis results. As in this test hole, resistivity log and magnetic susceptibility log were conducted. The charts from these logs are shown in same figure. Q values fall between 10 and 50. No change in velocity or resistivity curves can be seen with

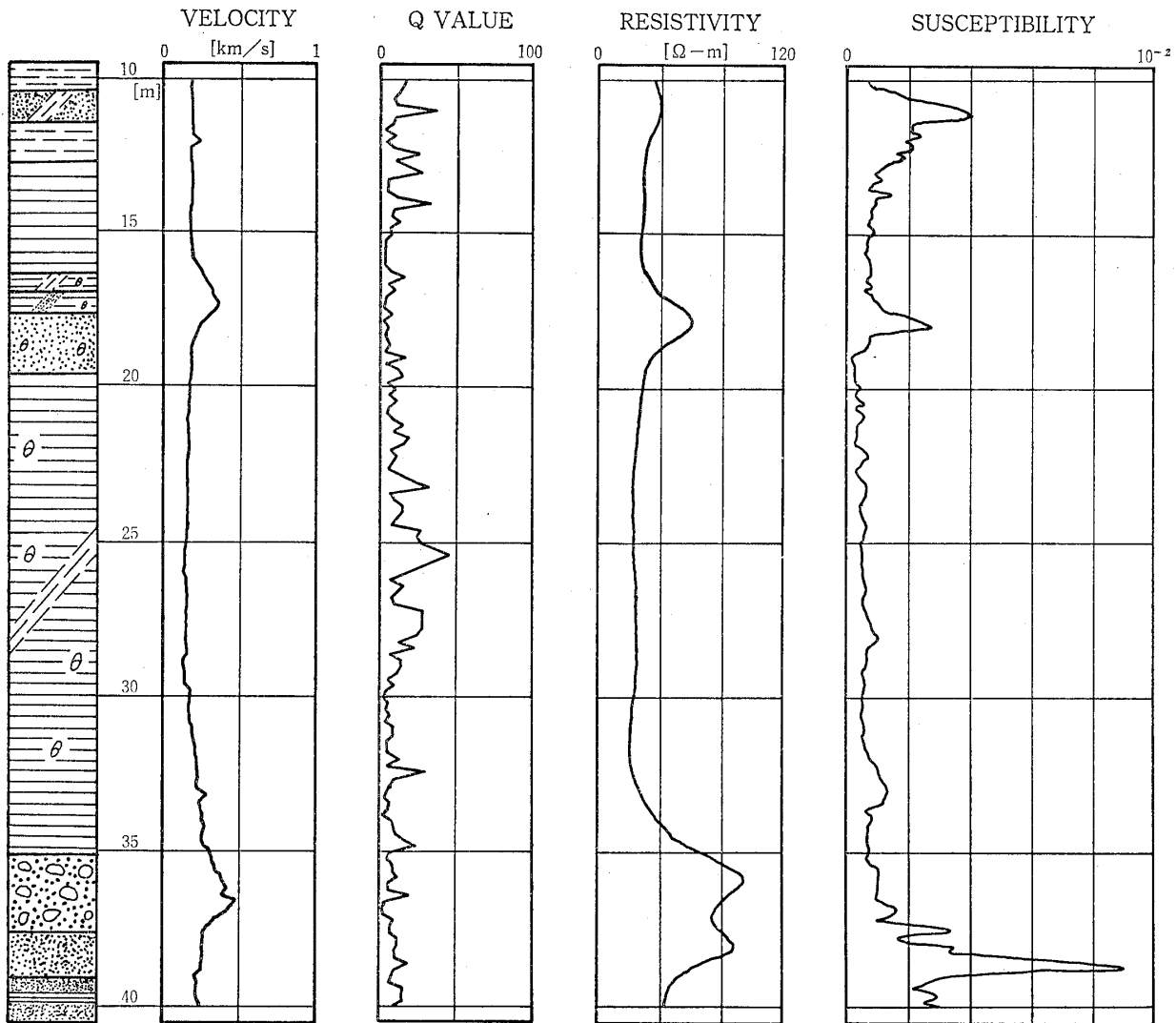

Fig.15 Results of analysis

depths from 20m to 30m. However, Q value curve changes considerably at depth around 25m. Minor change in magnetic susceptibility curve can be seen as well, which might be due to the existence of thin silt layer mixed in clay layer.

4 CONCLUSION

The new seismic source (H-S source) has achieved a five-fold increase in radiation power without increasing the required energy source. With conventional source, it is difficult to obtain records from hard ground having S wave velocity exceeding 1km/s. However, new seismic source has proved to make it feasible to obtain S wave records from such hard ground. At present, we are still engaging in research for the theme, "Up to what velocity can our new seismic source applied?". We are confident, it is equal to handling S waves of 3.0 km/s.

The most recent development work has been concentrated exclusively on the source, while the problems with the receiver are remained. Prominent one among them is the decrease in frequency response of the unfixed type receiver in frequency band higher than several kHz. The new seismic source achieves greater radiation power by generating higher frequency waves than conventional source. If the receiver does not have optimum frequency response, it will be difficult to improve the applicability of the new seismic source to even harder ground. As such, the improvement of the frequency response of the unfixed type receiver is one object of future research and development.

After considering the relationship of frequency band and amount of strain between earthquake and Suspension P-S Log, Q values must be used for investigation of ground behavior during earthquakes. However, we believe that the analysis for Q values combined to other logging data, such as velocity, resistivity, magnetic susceptibility etc., is a way of obtaining greater understanding of the characteristics of the grounds.

5. ACKNOWLEDGEMENTS

The authors wish to thank Queen's University for their continuing support our field experiments. Special thanks are extended to Dr. R. P. Young of Queen's University for giving us the permission to use the data of Fig. 13 in this paper.

References

- Imai, T., Tonouchi, K. and Kanemori, T. (1980): Evaluation of Q value Using S-wave Logging Records., OYO Technical Report, No.2, p. 51-69.
- Kitsunezaki, T. (1978): Indirect Excitation Type Source for Shear Wave Logging (1)., BUTSURI-TANKO, Vol. 31, No.6, p.1-9.
- Ogura, K. (1979): The Development of Suspension Type S-wave Log system., OYO Technical Report, No. 1, p.143-159.
- Ogura, K. and Nakanishi, S. (1980): Development of the Suspension S-wave Logging System (Report No. 2)., OYO Technical Report, No.2, p.37-50.
- Tanaka, K., Inoue, S. and Ogura, K. (1986): Development of a Suspension PS Logging System's Seismic Source for Hard Ground., SEG Annual Meeting Expanded Technical Program Abstracts, p. 39-41.

サスペンション P-S 検層システムの開発 (第3報)

田中賢治・小倉公雄

概 要

サスペンション P-S 検層システムは 1974 年から開発が進められている。現在のシステムには S 振源と P-S 振源の 2 種類の振源がある。S 振源は S 波のみを発生させ、P-S 振源は P 波と S 波を同時に発生させる振源である。

これまでの経験から、S 波速度が 500m/s 以下の地盤では S 振源で非常に良好な S 波の記録が得られるが、S 波速度が 500m/s を越えると、P-S 振源の方が良好な記録となることが分かっている。さらに S 波速度が 1km/s を越えると、P-S 振源を用いても S 波速度を決定できるだけの記録が得られなくなる。そこで、より速い速度の地盤でも良好な記録を得るために、新しい振源 (H-S 振源) を開発した。H-S 振源と従来の振源との違いはその放射インピーダンスにある。硬い地盤で有効な波を発生させるためには、放射インピーダンスを大きくしなければならない。放射インピーダンスを増大させるために次の 2 種類の方法を採用した。第 1 の方法は振動板の面積を大きくすることで、第 2 の方法は周波数の高い波を発生させることである。H-S 振源の振動板の形状は、面積を大きくするためにシリンダー型にし、この振動板の内側をハンマーで打撃することにより周波数の高

い波を発生させ、放射インピーダンスの増大を試みた。その結果、振源の大きさや振源を駆動するためのエネルギーを増大させることなく、放射インピーダンスを約 5 倍増大させることができた。H-S 振源を使用した場合、これまで良好な記が録得られなかった S 波速度 1km/s 以上の地盤でも、良好な S 波の記録が得られるようになった。現在、H-S 振源の適用範囲を確認するための実験をすすめているが、S 波速度 3m/s までの地盤での使用は可能であった。

ハードウェアの開発と同時にデータの利用法についての開発もあわせて行った。その一例として Q 値 (減衰定数) の算出を試みた。Q 値は S 波速度と同様に地震時における地盤の挙動を知るための重要な要素である。サスペンション P-S 検層法から求めた Q 値を地震時における地盤の挙動を解明するためのデータとして利用するには、実際の地震波と検層に用いた波の周波数帯域やひずみ量との違いを十分に考慮した上で利用しなければならない。今回解析を行ったデータのなかに、S 波速度と比抵抗値はほとんど変化していないが、Q 値や磁比率が変化する例が見られた。このことは S 波速度や Q 値を電気検層や他の検層結果と併せて評価することにより、地盤のより詳細な情報を引き出すひとつの手段になり得るものと考えている。